

AC/DC Converter (Power Module) Application guide 2022

1. Foreword.....	3
1.1 Warnings.....	3
1.2 Precautions.....	3
2. Selection Guide for Converter.....	4
3. AC/DC Converter Application Notes.....	6
3.1 Basic Test Circuit Connection.....	6
3.2 Typical Application Circuit.....	6
3.3 EMC Recommendation Circuit.....	7
3.4 Load Requirement for the Multiple Output Converter.....	7
4. Basic Performance Test.....	8
4.1 Output Voltage Accuracy.....	8
4.2 Line Regulation.....	8
4.3 Load Regulation.....	8
4.4 Conversion Efficiency.....	8
4.5 Ripple & Noise.....	9
4.6 Insulation Characteristics.....	11
5. FAQs.....	11
5.1 Grounding----Input and output.....	11
5.2 Surge Current.....	12
5.3 Leakage Current.....	12
5.4 AC/DC Input.....	12
5.5 Relations between the Class I, II equipment and the protection ground terminal FG.....	12
5.6 Transient Change of Input.....	12
5.7 No-load Use of Output.....	12
5.8 Operating Temperature.....	13
5.9 Voltage Marked on the Product's Shell.....	13
5.10 Radiated Susceptibility (RS).....	13

5.11 EMC Peripheral Recommendation Circuit.....	13
5.12 Power Timing Requirements.....	13
6. AC/DC Converter Application Safety Design.....	14
6.1 Marking Requirements.....	14
6.2 Material Requirements.....	14
6.3 Clearance and Creepage.....	14
6.4 Input Capacitor.....	14
7. Heat Dissipation in AC/DC Converter Applications.....	14
7.1 Natural Air Cooling.....	14
7.2 Forced Air Cooling.....	15

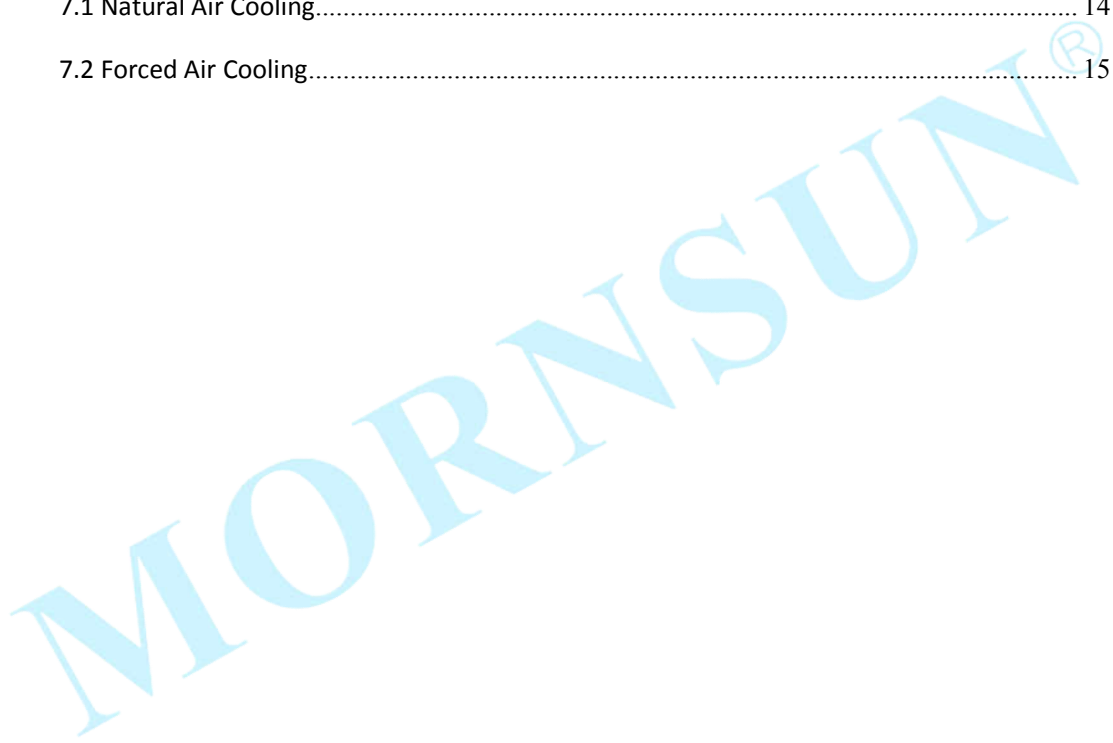

1. Foreword

Following guides should be carefully read prior to operation. Improper operation may result in the risk of electric shock, damaging the converter, or fire, etc.

1.1 Warnings

(1) The converter must be handled with care to avoid the product damage caused by the impact or fall.

(2) Do not open the shell or touch internal components to avoid the product damage of electrostatic, components stress, etc.

(3) Do not bend the pins of the product in order to avoid the internal PCB from breaking which would break the electrical connection and make the product work abnormally.

(4) When the converter is in operation, keep a distance away from the converter or do not touch the heat sink and shell to avoid potential hurts during improper cooperation.

1.2 Precautions

(1) Please make sure the input terminals, output terminals, signal terminals and necessary peripheral components are properly connected in accordance with the “design reference” and “Dimensions and Recommended Layout” in the stated datasheet.

(2) AC/DC converters are used in the primary transmission stage of a design and thus, should be installed in compliance with certain safety standards.

(3) A fuse is required to be connected in the input AC line (L) to meet the safety requirements in operation. Please refer to the corresponding datasheet for the recommended fuse part number.

(4) Manufacturers must ensure that the input/output of the module will not cause short circuit due to engineers' mistakes.

(5) The application circuits and parameters shown are for reference only. All parameters and circuits are to be verified before completing the circuit design.

(6) If the converter is stored or out of work for more than half a year, it is suggested to have the converter aged for 1 hour at no load every half a year to ensure the long lifetime and the application of high reliability.

(7) The general AC/DC converter is not suggested to operate for a long time under high temperature, and it is strongly suggested to replace new converter every one or two years if it has to be operated under high temperature. There should not be large heating device around the converter, such CPU, electric machine, etc.

(8) The slight noise inside the converter is normal when operated at light load or no load.

(9) The installation and use of the converter should be guided by professional designers.

(10) The case of converter should be next to the device shell with heat-conducting glue if operated in closed environment.

(11) The withstand voltage test is limited destructive test and the converter should not be tested multiple times.

(12) MORNSUN has the right to update this guide at any time without notice, please check the most up to date information on MORNSUN website before use. For other questions, please refer to *AC/DC Converter Failure Analysis*.

2. Selection Guide for Converter

First, confirm the specification of the converter and select the converter according to the required parameters.

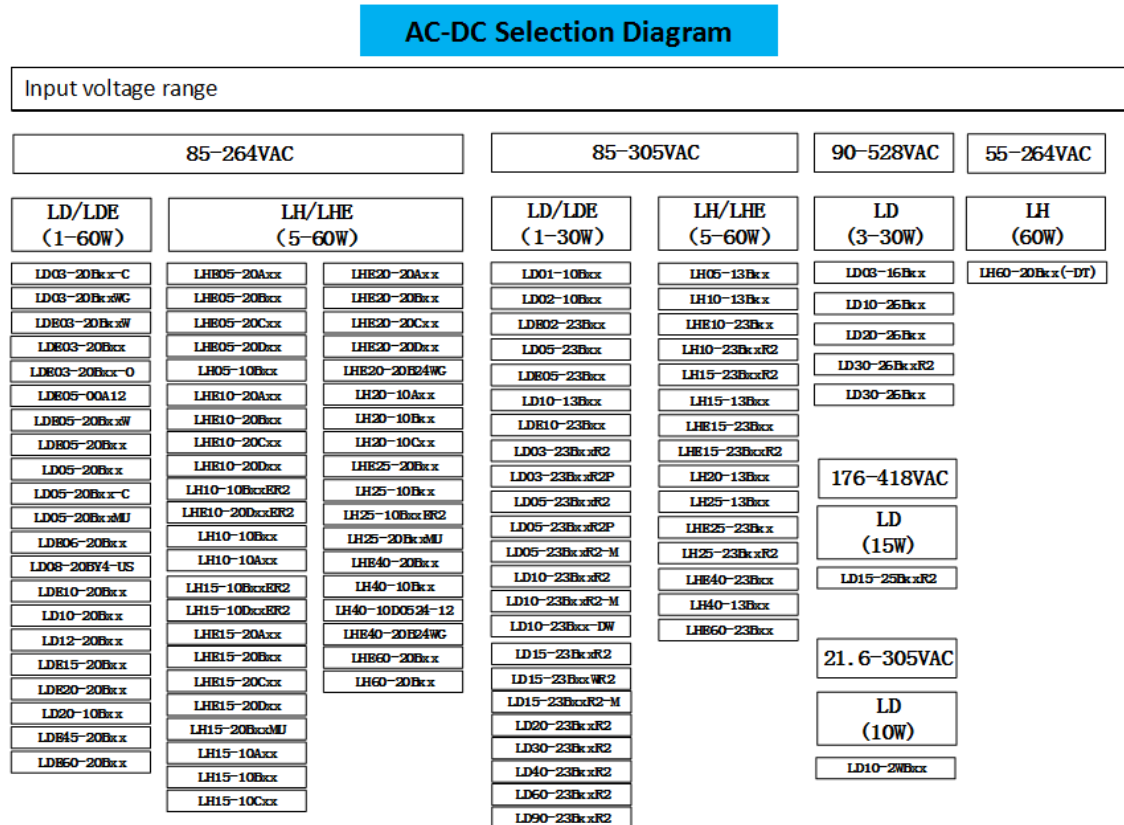

Diagram 2-1: MORNSUN AC/DC Converter Basic Selection Diagram

Note: MORNSUN reserves the right to add new product into above selection diagram without notice.

Step 1, confirm the input source type

Please confirm the input source type is AC or DC. Generally, AC/DC converter is available for AC input, and DC/DC converter is used for DC input. (MORNSUN AC/DC converter can also be used for DC input voltage)

Step 2, select the standard reference voltage according to the input voltage range. Please refer to Diagram 2-1 for the reference voltage range.

Step 3, select the output power and package type based on the load. MORNSUN has multiple packages that include SIP, DIP, Chassis mounting and DIN-Rail mounting. In addition, for LD/LH series (5-25W), the suffix A2/A2S/A3 are chassis mounting (A2S is reduced size based on A2; A3 has detachable wiring port), the suffix A4/A4S are DIN-Rail mounting (A2S is reduced size based on A4). For LH40 and LH60 series, the suffix A5 is chassis mounting (A5 is increased size based on A2) and the A6 is DIN-Rail mounting (A6 is increased size based on A4). Please refer to below diagram for output power selection as well as the package. (语句有调整)

	Chassis mounting	DIN-Rail mounting
LD/LH 05~25	A2、A2S、A3	A4、A4S
LH40、LH60	A5	A6
LHE 05~25	A2	A4
LHE40、LHE60	A5	A6

Step 4, select the right output voltage based on the load type.

Rated output voltages of MORNSUN products are: 3.3V, 5V, 9V, 12V, 15V, 18V, 24V, 48V, $\pm 5V$, $\pm 12V$, $\pm 15V$ and $\pm 24V$. AC/DC converters can be operated in series to get a particular output voltage, for example: LH05-10A05 in series products can get a 10VDC output voltage. Another example is that LD10-23B05R2 与 LD10-23B12R2 in series can get a 17VDC output voltage.

Step 5, select the isolation voltage

Isolation can make the input and output of the converter to be two independent (not common grounded) power supplies. In industrial bus system, isolation can rise the loop's resistance in harsh environment such as thunder strike and arc noise. In hybrid circuit, the noise can be isolated for sensitive analog circuit and digital circuit. In multi-voltage power apply system, isolation can achieve voltage conversion. The isolation voltage of MORNSUN AC/DC converter are 2000VAC, 2500VAC, 3000VAC and 4000VAC.

For simple non-isolation design, MORNSUN's LS01-K3B05SS and LS03-K3B12SS are available.

It is suggested to select the standard AC/DC converter because they are more cost-effective, reliable and shorter sample delivery time, etc. For special requirements, such as higher isolation voltage, ultra wide input voltage range, high temperature, EMC certification, please contact our technical service engineer.

3. AC/DC Converter Application Notes

3.1 Basic Test Circuit Connection

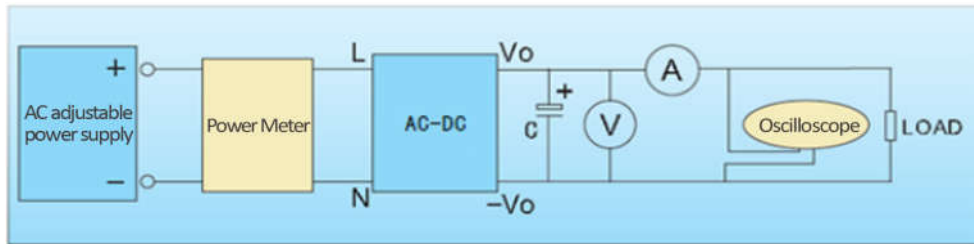

Diagram 3-1: Basic Test Circuit Connection

3.2 Typical Application Circuit

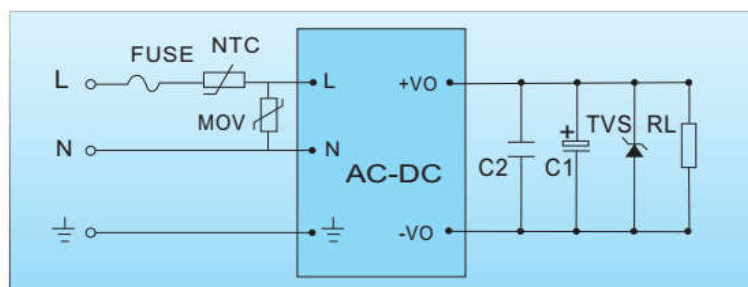

Diagram 3-2: General AC/DC Typical Application Circuit

(1) The FUSE in the input should be slow blow fuse with safety certification. The recommendation value are 1A/250V for lower than 5W, 2A/250V for 10W to 15W, 3.15A/250V for 20W-60W (Rated voltage can be increased or decreased depending on the input voltage range). Please refer to datasheet for specific recommendation value.

Note: If the current value of the fuse is too large, the protection of the fuse will fail. If the current value of the fuse is too small, the fuse will be easy to be falsely blown caused by the input capacitor charging when starting. In addition to considering power, environmental factors such as transient surges need to be considered.

(2) MOV is a metal oxide varistors, which can prevent the surge voltage in the input. Please refer to the datasheet for the MOV selection.

(3) NTC is a negative temperature coefficient thermistor, which can reduce the inrush current during starting. If the input power is large, it is recommended to select winding resistance. Please refer to the datasheet for the specific resistance.

(4) C1 is a filtering electrolytic capacitor. It is suggested to use the electrolytic capacitor with high frequency and low resistance. Please refer to the datasheet for the recommended capacitance, and 20% voltage derating of the capacitor should be considered.

(5) C2 is a ceramic capacitor which is used to eliminate the high frequency noise.

(6) TVS is suggested to protect the back-end circuit when the converter is abnormal.

Note: For the dual or triple output converter with the same primary circuit, the secondary circuit can be viewed as two or three independent converters to select the filter parameters.

3.3 EMC Recommendation Circuit

EMC filter circuit is required when applied in a harsh environment of electromagnetic compatibility. Diagram 3-3 is a typical input EMC filter circuit for reference only. Please refer to the datasheet for the specific recommended EMC filter circuit and parameters.

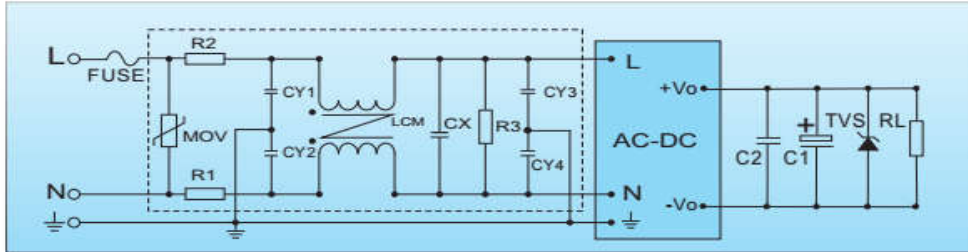

Diagram 3-3: Typical Input EMC Filter Circuit

3.4 Load Requirement for the Multiple Output Converter

For the normal multi-output converter, only primary output has regulated output. The voltage accuracy of the secondary output is greatly affected by the load, so it is required that all outputs of the converter should be balanced with the proportion of the load (Load gap should be within 5%).

For example, MORNSUN dual output LH05-10D0505-01, the primary current at full load is 900mA and the secondary current at full load is 100mA. If the actual load of the primary output is 90mA in customer's practical application, the secondary current needs to be 10mA according to the proportion of load balance.

If the customer needs a higher voltage accuracy for the secondary output, it is recommended to add a low dropout linear regulator behind the secondary output (the low dropout linear regulator is used in the condition of rising output voltage caused by the light load of the secondary output). Shown as Diagram 3-4,

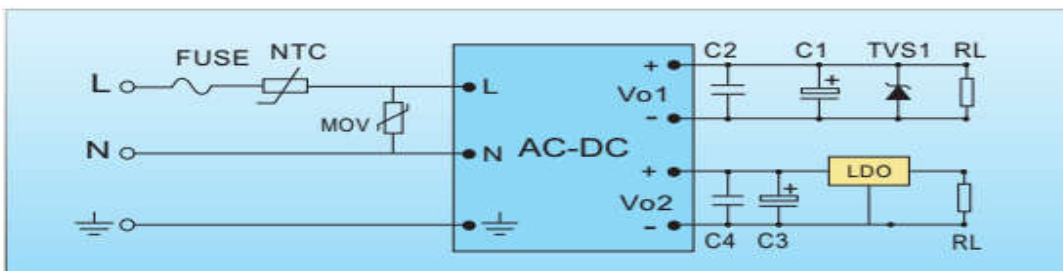

Diagram 3-4: Dual Output Typical Circuit

4. Basic Performance Test

Note: The nominal input voltage of MORNSUN AC/DC converter are 115VAC or 230VAC.

4.1 Output Voltage Accuracy

At nominal input voltage, output at full load, nominal output voltage required by specification is V_{nom}	$\text{Output Voltage Accuracy} = \frac{V_{out} - V_{nom}}{V_{nom}} \times 100\%$
At Nominal input voltage, output at full load, measured output voltage is V_{out}	

4.2 Line Regulation

At nominal input voltage, rated load, measured output voltage is V_{outn}	$\text{Line Regulation} = \frac{V_{outn} - V_{mdev}}{V_{outn}} \times 100\%$
At input voltage upper limit, rated load, measured output voltage is V_{outh}	
At input voltage lower limit, rated load, measured output voltage is V_{outl}	
V_{mdev} reads the maximum value deviated from V_{outn} between V_{outh} and V_{outl}	

4.3 Load Regulation

At nominal input voltage, 10% load, measured output voltage reads V_{b1}	$\text{Load Regulation} = \frac{V_b - V_{b0}}{V_{b0}} \times 100\%$
At nominal input voltage, 100% load, measured output voltage reads V_{b2}	
At nominal input voltage, 50% load, nominal output voltage reads V_{b0}	
V_b reads the maximum value deviated from V_{b0} between V_{b1} and V_{b2}	

4.4 Conversion Efficiency

The conversion efficiency of AC/DC converter: The voltage and current tested by the multimeter in the input can't be directly taken as the input power, and it generally uses the power meter to read the input power P_{in} directly. The output power is calculated by the actual output load I_{out} and output voltage V_{out} .

At nominal input voltage P_{in} , full load I_{out} ,
measured output voltage reads V_{out}

$$\text{Efficiency } \eta = \frac{I_{out} \times V_{out}}{P_{in}} \times 100\%$$

Note: The input is AC, the internal inductive reactance and capacitive reactance can result in phase difference occurred in the input voltage and current and cause input current wave distorted.

4.5 Ripple & Noise

4.5.1 Ripple & Noise Test Method

The ripple and noise is the periodic and random AC variation superimposed on DC output, and it also affects the output accuracy. Generally, ripple and noise is calculated with peak to peak value (mVp-p).

Step 1, set the oscilloscope bandwidth to 20MHz to eliminate high frequency noise effectively.

Step 2, use parallel cable method, twisted-pair cable method or contact measuring method.

Shown as Diagram 4-1.

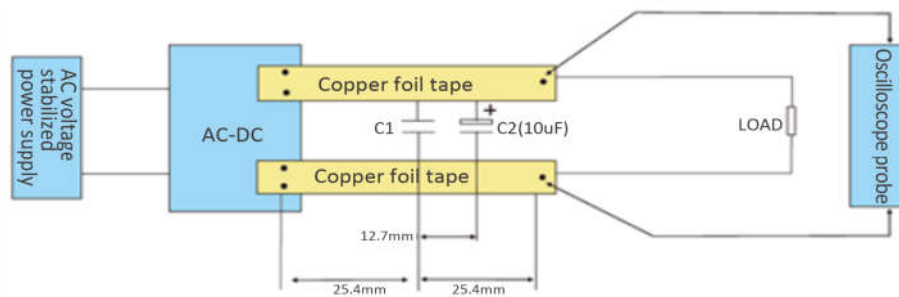

Diagram 4-1: Parallel Cable Measuring Method

Note:

- (1) C1=1uF high-frequency ceramic capacitor.
- (2) C2=10uf (electrolytic capacitor) and the withstanding voltage should be derated to 80% or more, which should be accordance with the recommended value on the datasheet.
- (3) The distance between two parallel lines copper foil tape is 2.5mm, and the total voltage drop of two parallel lines copper foil tape should be less than 2% of output voltage.

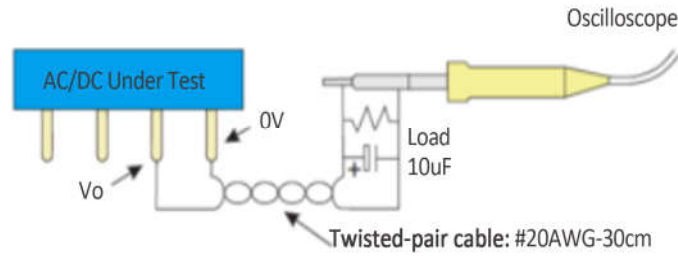

Diagram 4-2: Twisted-pair Cable Measuring Method

The other test method is the twisted-pair cable measuring method shown as Diagram 4-2, connect the twisted-pair cable composed of 30cm long and #20AWG to the Vo and 0V of the switching power supply that needs to be tested, and add a resistance dummy load between Vo and 0V. Then, connect a 10μF electrolytic capacitor at the end of the twisted-pair cable, when the point of measurement connecting, one end is connected to the Vo, and the other end is connected to Grounding ring.

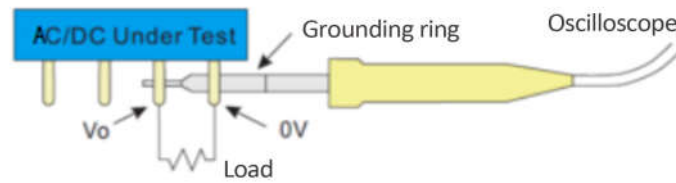

Diagram 4-3: Contact Measuring Method

As the variety of high-frequency noise received by the oscilloscope's ground clamp can interfere the measurements, the contact measuring method can be used to eliminate the interference, shown as Diagram 4-3. And, the actual measured ripple and noise varies with the circuit and the external components, shown as Diagram 4-4.

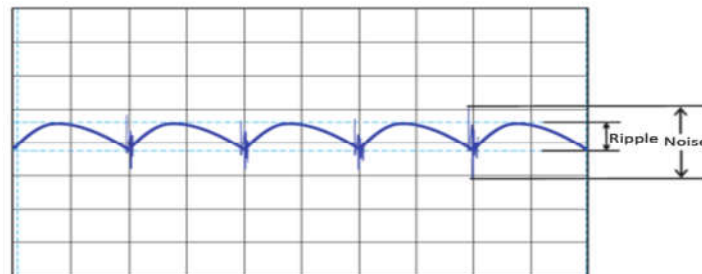

Diagram 4-4: Ripple & Noise Test Waveform

4.6 Insulation Characteristics

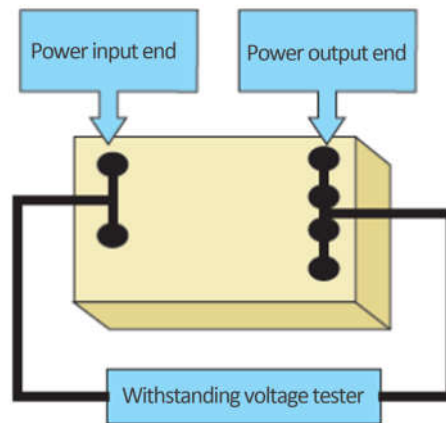

Diagram 4-7: Withstand Voltage Test

Withstanding voltage test method:

Connection shown as Diagram 4-7, rise the withstanding voltage from 0 slowly according to the test standard of withstanding voltage, and maintain for one minute at the set point when set to the set value.

Insulating Strength:

To short the pin of input and output respectively, apply an isolation voltage between the input and output. Test for one minute.

5. FAQs

5.1 Grounding-----Input and output

Input ground: AC/DC converter generally has three pins, Live Wire L, Neutral Wire N, and Floating Ground PE. PE is usually connected to the equipment casing or the ground wire in the power grid.

Output grounding: In the actual application, some customers connect the output ground terminal with the protection ground terminal directly, as shown in Diagram 5-1. Such connection may result in abnormal output or damage of the module because of lightning, surge and group pulse, etc., so it is suggested to connect the output ground terminal with the protection ground terminal through a Y capacitor(1000Pf/400V is normally recommended) as shown in Diagram 5-1.

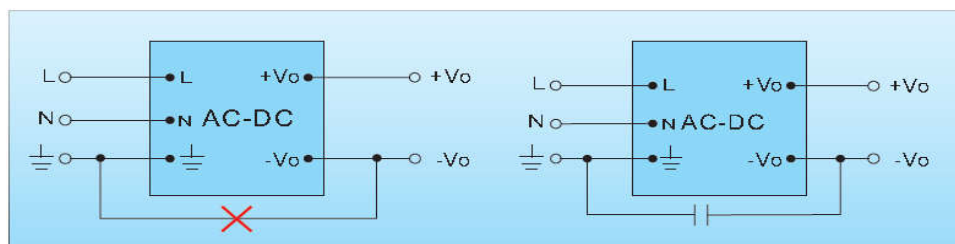

Diagram 5-1: Connecting method of Negative Output and Protection Ground

5.2 Surge Current

The surge current is classified into the inrush current at start time and the current formed by the high surge voltage sensed during operation. The main solution is to add protective components such as thermistor or wire wound resistor in the input to suppress the inrush current, and use the MOV for protection and releasing energy to reduce the high voltage surge current.

5.3 Leakage Current

There are two kinds of leakage currents:

- 1). the leakage current between the input terminal and the floating ground terminal when the product operates normally;
- 2). the leakage current between the isolation belts when the product is in the pressure withstanding test.

5.4 AC/DC Input

Usually the full-bridge rectifier is used on the input terminal of AC/DC power supply to meet the AC and DC power supply requirements.

5.5 Relations between the Class I, II equipment and the protection ground terminal FG

EN60950 clearly defines the Class I and II equipment:

Class I equipment is provided with the basic insulation and a connecting device capable of connecting the conductive part with dangerous voltage to the protection grounding conductor in shell of the basic insulation failure. Class I equipment is also equipped with the protection ground terminal FG pin, such as LH series product.

Class II equipment means the equipment which electric shock prevention depends on both the basic insulation and the additional safety protection measure (for example the equipment with dual insulation or enhanced insulation). Such equipment does not rely on the protection grounding or the protection measures of mounting condition. Class II equipment has no protection ground terminal FG pin, such as LS/LD series product.

5.6 Transient Change of Input

The transient voltage change of the input power wire may destroy the power converter. If the transient voltage changed at the input terminal is higher than the top limit of the input of converter, the protection circuit must be connected at the input terminal.

5.7 No-load Use of Output

For the multi-outputs product, output voltage may be 20% or higher than the nominal at no load. In actual application, it is recommended to ensure the minimum load to be 10% full load.

5.8 Operating Temperature

When the product operates in a high temperature environment, the temperature of its internal components will be much higher than the ambient temperature. In order to ensure the reliable operation of the converter, the maximum operating ambient temperature of the conventional product is 70 °C or 85 °C, and derating is required when the ambient temperature is 55 °C. When the product operates in a low temperature environment, the power derating is also required because of the low-temperature characteristics of internal electrolytic capacitor and other components. Moreover, the output ripple and the noise are higher than that of constant-temperature value. For the specific contents of derating curve, please refer to datasheet for details.

5.9 Voltage Marked on the Product's Shell

The silk screen marked on the product is 100VAC-240VAC. But why is 85VAC-264VAC on the datasheet?

It is mainly in consideration of safety certification concerns. Generally, the certification authority tests the product performance by $\pm 10\%$ or $\pm 15\%$ of the input voltage range marked on the product, so the voltage marked on the product case is usually 100VAC-240VAC according the industry practice.

5.10 Radiated Susceptibility (RS)

The internal circuit of the switching power supply such as the control circuit, the loop regulation circuit, etc., will affect the normal work when encountering a strong radiation. The test standard of RS for the switching power supply is IEC/EN61000-4-3 10V/m, which is used to test whether the converter work normally. When the strong RS close to the switching power supply, such as the intercom and other strong radiation equipment, the RS will be several times higher than the lab, so the strong radiation equipment should be far away from the switching power supply when using.

5.11 EMC Peripheral Recommendation Circuit

The front input of AC/DC power supply is high voltage, and the input power supply environment is relatively complicated, so it is a must to add EMC protection circuit in the input, especially for the small product such as LD01/02 and LS01/03/05 series. It is hard to design the protection circuit inside the converter because of the size. The customer need to follow the datasheet to design the recommend peripheral circuit, otherwise the product has the risk of damage under the complicated power supply environment.

5.12 Power Timing Requirements

When multiple systems or multiple functional circuits start the work at the same time, the

control circuit generally is required to work first to ensure that the system can initialize properly and each components charged. Therefore, when selecting the power supply for each systems or functional circuits, the start-up time of the power is the key point if the system needs higher timing. When the power supply is abnormal, the control circuit is required to be power-down at last to ensure the whole system close properly. So, the hold-up time of the converter also needs to focus on.

6. AC/DC Converter Application Safety Design

6.1 Marking Requirements

Wherever, there are fuses, protective grounds, or switches, clear symbols should be indicated according safety standards. Touchable dangerous high voltage and energy sources should be marked with “Caution!” indications.

6.2 Material Requirements

Input cables of L, N and FG should be brown, blue and yellow/green cables respectively. Ensure that the ground cable(yellow & green cable) of Type I devices(those that rely on basic insulation and protection ground to avoid electric shock) are securely connected to the ground, and the earth resistance is lower than 0.1Ω .

6.3 Clearance and Creepage

The clearance of L and N that are in front of the fuse should be above 2mm. The creepage is above 2.5mm. The clearance between the input and metal shell or SELV circuit is above 5mm. The creepage is above 6.4mm (the creepage and clearance is required to increase if applied in high altitude environment).

6.4 Input Capacitor

If the X capacitor is connected in the input of the product to improve the EMI performance, and if the capacitance is too large, it is required to connect the discharge resistance in parallel. The discharge time constant is equal to the product of the capacitor and the resistance. Besides, the voltage of the input terminal of the product should drop to 37% after the input powers off for one second according the safety requirements.

7. Heat Dissipation in AC/DC Converter Applications

7.1 Natural Air Cooling

For miniature and high power density converters (they are mainly onboard converters), natural air cooling is widely used as the main heat dispatch method due to the cost and space concerns. Usually the on-board converters have following main ways to cool:

(1) Heat dissipates to the ambient air through the converter shell or exposed surfaces by means

of convection. Heat may also dissipate to ambient air if there is a gap between the converter and the PCB.

(2) Heat dissipates from the converter shell and exposed surfaces to PCB by radiation.

(3) Heat conducts through terminals (pins) to PCB.

7.2 Forced Air Cooling

In many applications, the operating condition of the converters are not well improved even if a heat sink is installed. In this shell, it is usually to install a fan as the main heat dissipation method. The general guideline for fan installation is that the direction of the fan can be horizontal for the long-shaped converters, and the direction of the fan in the channel can be vertical to form chimney-effect to improve the heat dissipation capacity. In addition, the another method is to coat with a layer of thermal grease or fill other thermal materials between the fan and the converter to make the fan and the converter shell(or converter metal substrate) combined tightly to reduce the thermal resistance, but do not make the converter shell(or converter metal substrate) deformed due to too tight.

In high altitude condition, because of thin air, intensity atmosphere pressure, poor heat dissipation of the system itself, the forced air cooling or derating must be used to reduce the temperature rise of the system.